

Accurate Lock and Hardware Co.

Manufactures of
Custom Locks and Architectural Hardware

6500USD

Screen Door Lock - Installation Template

Note: All Dimensions Reflect Suggested Morrise Prep Dimensions. (Actual Lock Dimensions Are Slightly Smaller).

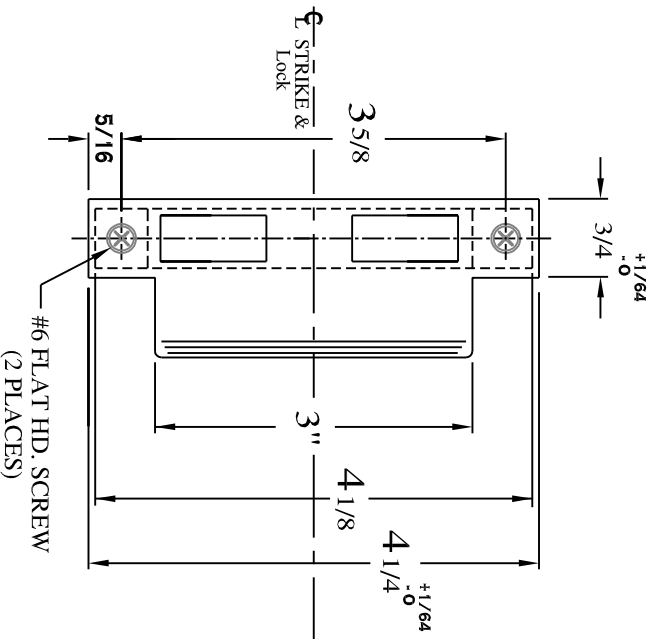
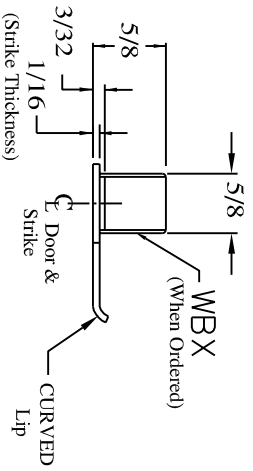

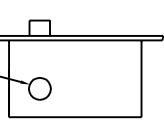
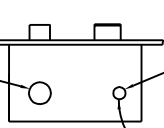
6525USD Passage	 <p>Both Sides Knobs/Levers</p>	6539USD Privacy	 <p>Both Sides Knobs/Levers</p>	<p>Emergency Key Outside Only, When Ordered</p>
--------------------	--	--------------------	--	---

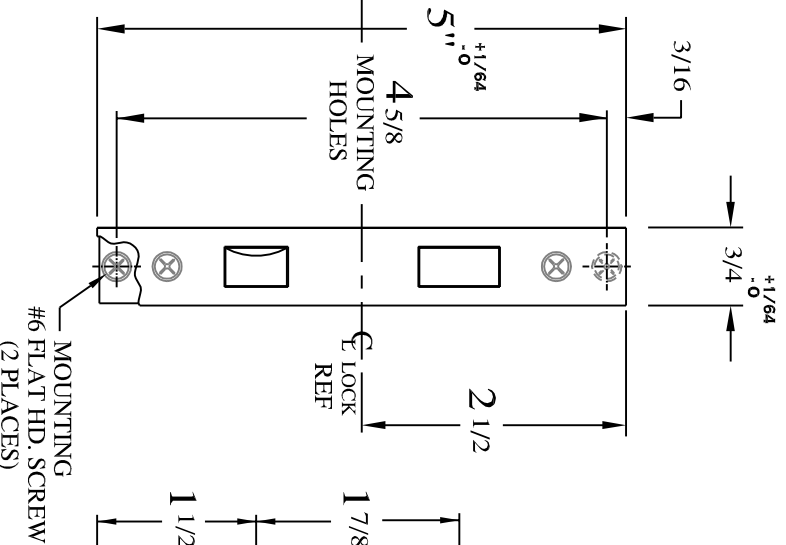

Responsibility
Door And Frame Manufacturers Are Responsible For Providing Adequate Construction Or Re-Inforcement For Proper Installation Of Hardware Shown.

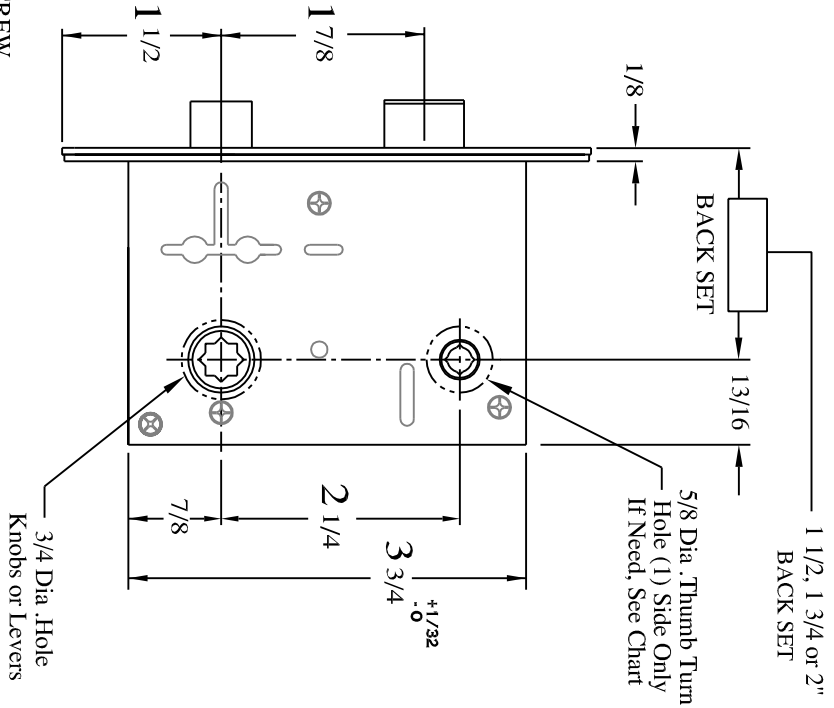
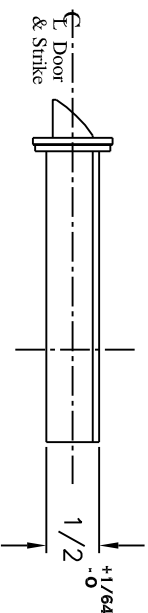

Universal Strike

Annie Place, Stamford, CT. 06902
(203) 348-8865 FAX (203) 348-5234
E-MAIL: Sales@Accurate.co
www.Accurate.co